

Fitting and Care Instructions for

JELD-WEN Ledbury Patio Door

IMPORTANT NOTE



Please adhere to Health and Safety guidelines when installing these doors.

Please note some parts of this product may need two or more persons to lift. Lifting aids like sucker clamps will also ease the handling.

All assembly instructions must be followed including the use of all posts to ensure the safe operation of this patio door.

Ref D3_M_0010_B

For further advice contact:

Tel: 01302 394000
Fax: 01302 787383

INTRODUCTION

JELD-WEN timber patio doors are designed and manufactured in Britain and use toughened safety glass to the highest specifications of BS.6206.

They are fully weather sealed to improve performance.

The patio is made from timber which is preservative treated for long life. It is supplied in component form (doors pre-assembled) ready for you to assemble, the 2 packs contains all the components you need for easy assembly.

Before commencing assembly read through the instructions VERY carefully, locating and identifying each component.

Familiarise yourself with all the components and how they fit together.

All nails/screws for assembly of the timber frame are supplied.



OTHER MATERIALS REQUIRED FOR CORRECT INSTALLATION

1. External wood adhesive
2. Non-corrosive masonry fixings to fix the timber frame to the structure
3. Silicone mastic (primer) to the surrounding brickwork
4. Microporous stain (breather type)
5. Damp Proof Course (d.p.c.)

TOOLS REQUIRED FOR CORRECT INSTALLATION

1. Power drill and drill bits
2. Tape measure
3. Spirit level
4. Screw driver (Pozidrive and slotted sets)
5. Hammer
6. Paint brush
7. Brace and 16mm bit
8. Craft knife

IMPORTANT POINTS

It is advisable to pre-drill for fixing screws into timber frame and doors.

△ To avoid problems at a later date it is **EXTREMELY IMPORTANT** to ensure that the frame is fixed in position square and that the sill is level.

MODEL	HEIGHT	WIDTH	DEPTH	SILL DEPTH
LED 16	2073mm	1590mm	115mm	142mm
LED 18	2073mm	1790mm	115mm	142mm
LED 21	2073mm	2090mm	115mm	142mm
LED 24	2073mm	2390mm	115mm	142mm
SLED 16	2073mm	1590mm	115mm	142mm
SLED 18	2073mm	1790mm	115mm	142mm
SLED 21	2073mm	2090mm	115mm	142mm
SLED 24	2073mm	2390mm	115mm	142mm

All dimensions are to outside of timber frame

Building Regulations

From April 2006 the requirements of Approval Document L and F will change. Please consult with your building designer to ensure compliance with these requirements.

Fitting and Care Instructions for

JELD-WEN Ledbury Patio Door

COMPONENT IDENTIFICATION AND CHECKLIST

Fixing Pack consisting:-

A	Timber Sill	<input type="checkbox"/>	M	Pile Carrier (Vertical)	<input type="checkbox"/>
B	Timber Jamb (Left)	<input type="checkbox"/>	N	Interlock outer/inner	<input type="checkbox"/>
C	Timber Jamb (Right)	<input type="checkbox"/>	O	Pile Carrier (Jamb) Inner (2 off)	<input type="checkbox"/>
D	Timber Head	<input type="checkbox"/>	P	Plastic T/Bar (Jamb) Outer	<input type="checkbox"/>
E	Track Section	<input type="checkbox"/>	Q	Timber Anti-Lift Block	<input type="checkbox"/>
F	Plastic Locating Bar (1Bottom)	<input type="checkbox"/>	R	Timber Threshold Piece	<input type="checkbox"/>
G	Plastic Locating Bar (Side)	<input type="checkbox"/>	S	Timber Door Stop (Top)	<input type="checkbox"/>
H	Plastic Locating Bar (Top)	<input type="checkbox"/>	T	Timber Door Stop (Bottom)	<input type="checkbox"/>
I	Fixed Door	<input type="checkbox"/>	U	Expanding Foam Seal	<input type="checkbox"/>
J	Sliding Door	<input type="checkbox"/>	V	Pile Carrier (Horizontal)	<input type="checkbox"/>
K	Timber Head Fillet Piece	<input type="checkbox"/>	X	Plastic T/Bar (Top)	<input type="checkbox"/>
L	Head Pile Carrier	<input type="checkbox"/>		Screw Pack	<input type="checkbox"/>

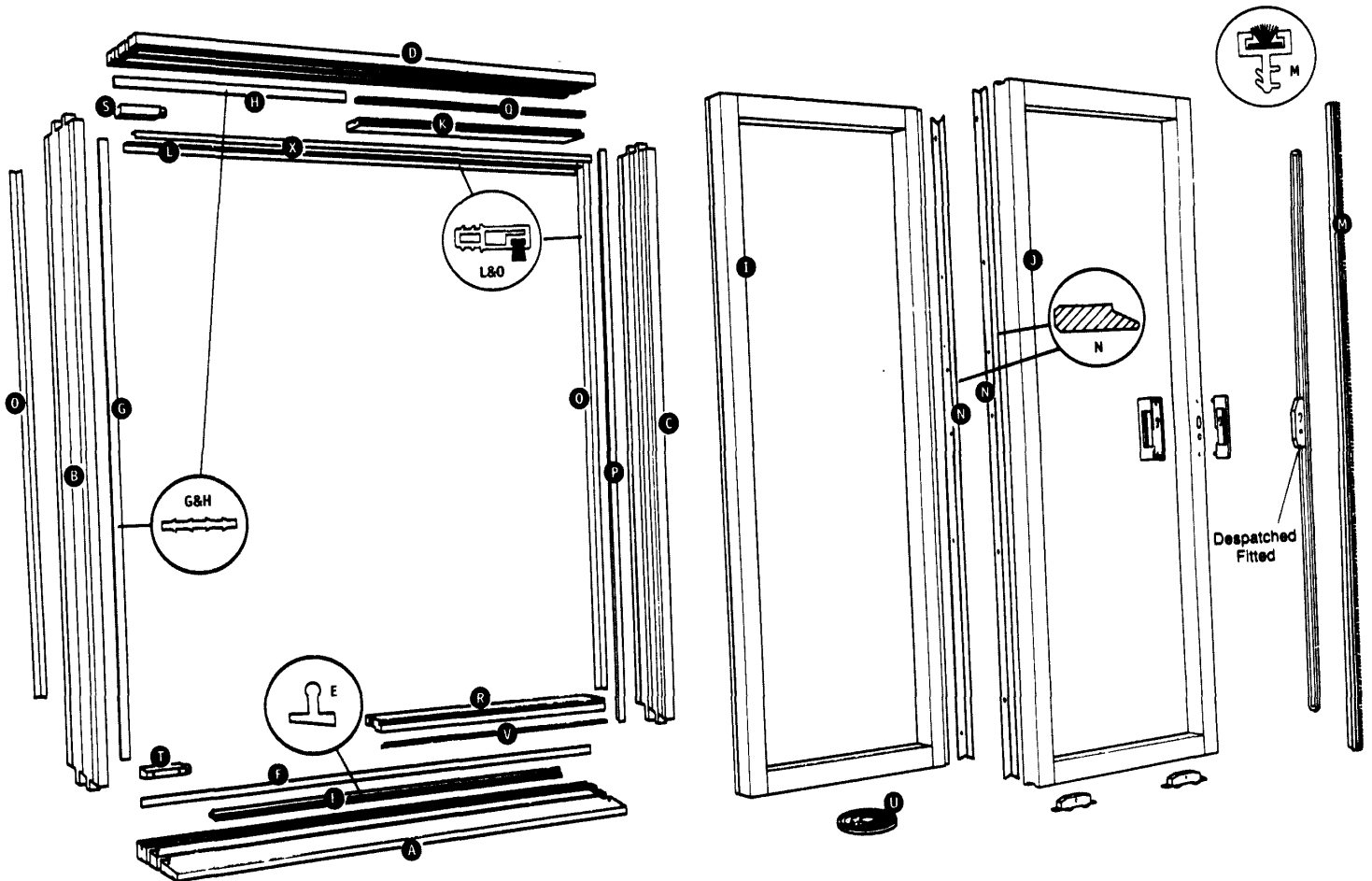

HARDWARE CHECKLIST

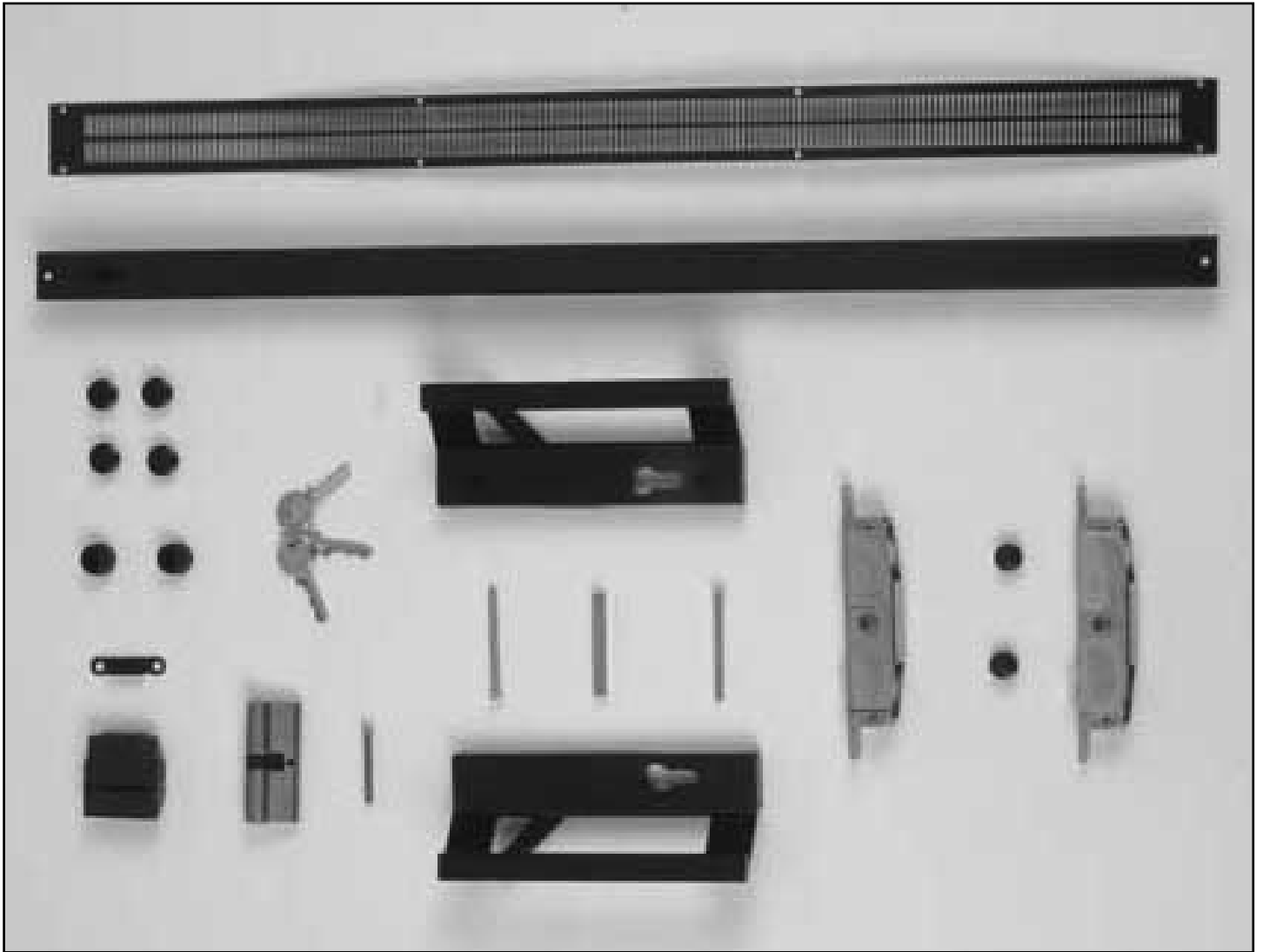

Included in this pack:

Inner and outer vent

Fixing pack

Handle pack

Fitting and Care Instructions for

JELD-WEN Ledbury Patio Door



- 1 Fit plastic locating bar to sill.



- 2 Apply wood glue to joints and assemble making sure that the 3mm groove lines up on the inside.



- 3 Screw together with screws - 60x70 provided.

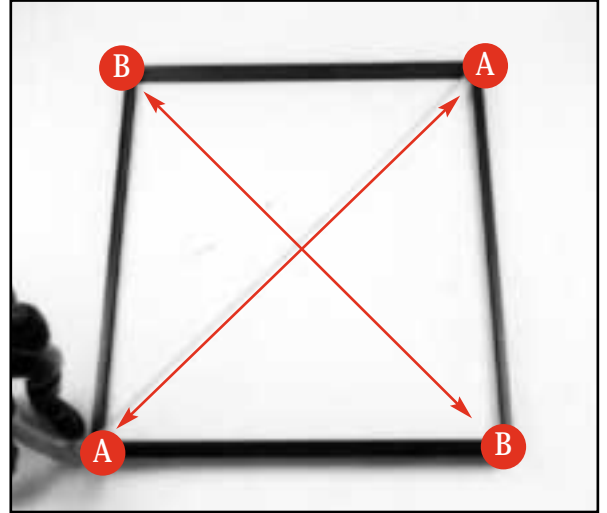

- 4 Check frame for squareness across the diagonals.
 $XX = YY$.



- 5 Fit into opening, set frame back 30mm over the cavity to conform to Part L Robust details. Wedge frame into the opening.

Fitting and Care Instructions for

JELD-WEN Ledbury Patio Door

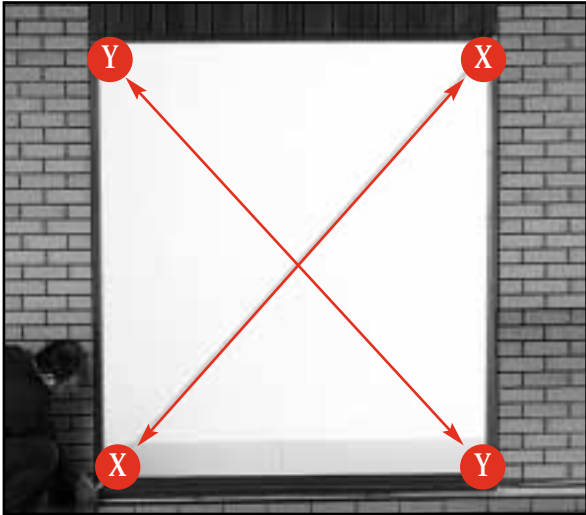

- 6 Check frame for squareness across the diagonals. AA should equal BB.

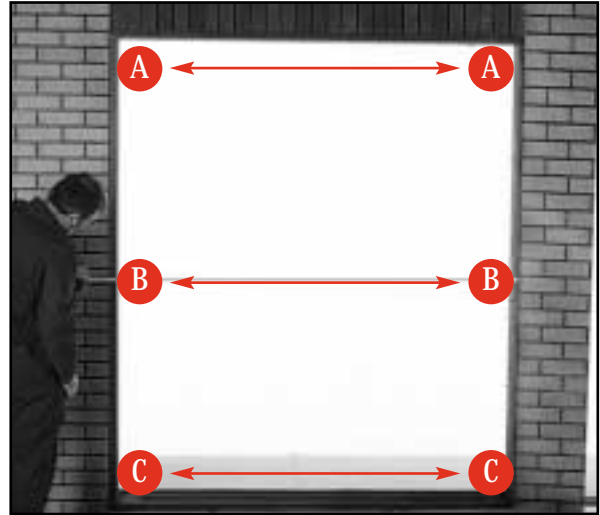

- 9 Check the horizontal dimensions, wedge and pack as required to ensure all are equal i.e. AA=BB=CC.



△ Safety and Security

- 7 The sill must be level. Pack beneath it to stop movement and ensure it is fully supported.

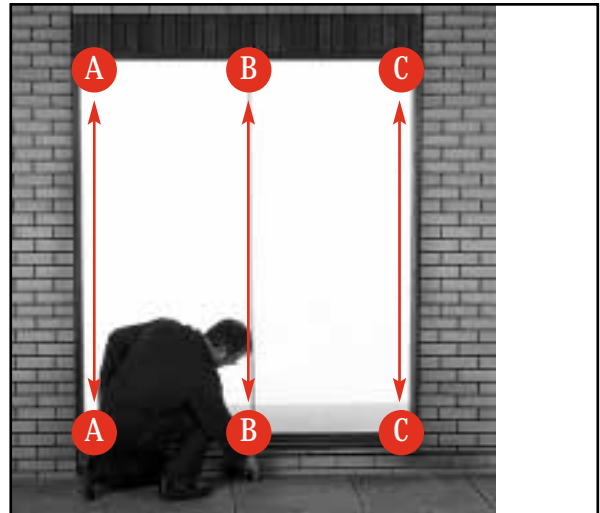

- 10 Check vertical dimensions are equal i.e. AA=BB=CC. Pack as required.



- 8 Check frame is plumb.

Fitting and Care Instructions for

JELD-WEN Ledbury Patio Door



- 11 Drill through frame into whole bricks/blocks to approximately 450mm centres.



- 12 Fix into opening using suitable fixing (not supplied) as fixing methods may vary).

△ Safety and Security

Subframe must be securely fixed to the brick before installation continues.



- 13 Locate the thinnest edge of the track against the outermost step in the sill, equal distances from left and right jambs. Screw into position using the 1" number 4 screws.



- 14 Insert side locating bar into inner groove on fixed door side (the side without lock bolts).



- 15 Using the pre-compressed foam seal, remove the white backing and stick to the inside of the frame. Start 50mm up on the locking door jamb and continue along sill and up to the top of the fixed door jamb against locating bars and push well into corners. If the foam tape has been left to expand re-compress with fingers before installing door.



16 Lay the short locating bar on the inside of the sill on top of foam tape as a temporary packer to avoid damaging the foam seal when placing fixed door in position.



19 Remove the short locating bar and slide into the fixed door top rail and, tap home.



17 Lift the fixed door onto the plastic locating bar (bottom) utilising the temporary packer.

Sliding Door

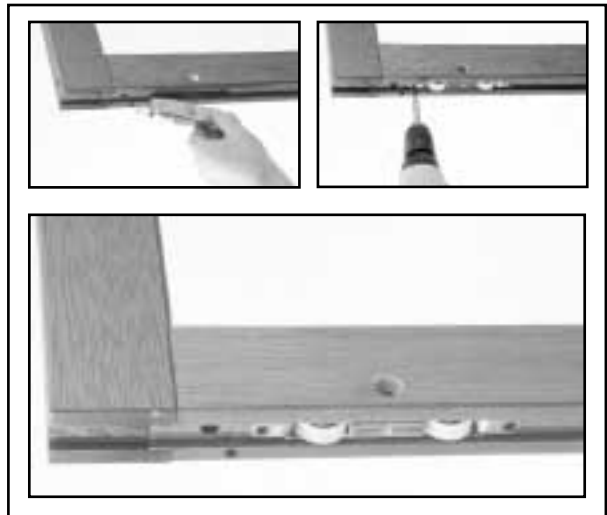

20 Fitting rollers to sliding door.



18 Slide the fixed door until it locates onto the side locating bar.



21 Mark drill holes as indicated on both ends of the **INSIDE FACE** of the sliding door, using a 16mm wood bit. Drill through the first half of the door into the mortise - **DO NOT DRILL** completely through the door. Place wheels into the mortise with the adjacent slot facing the hole. Screw into position using 1" No 6 screws.

Fitting and Care Instructions for

JELD-WEN Ledbury Patio Door



- 22 Insert the brushpile carrier into head, brush facing outwards.



- 23 Insert large pile carrier into the groove of the fixed door frame jamb with the pile facing the fixed door.



- 24 Inset large pile carrier into the locking Jamb with pile facing to the outside.

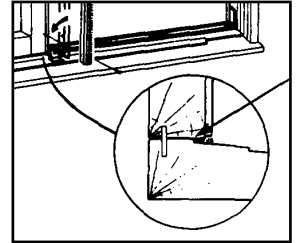
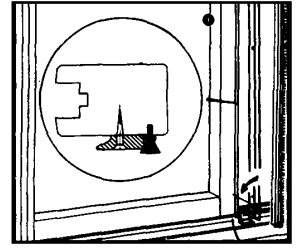

- 25 Insert pile carrier into groove on the interlock Jamb of the fixed door and butt interlock against pre-drilled vertical pile carrier. Fix using 6 No 1" screws supplied. Cut a 25mm length of foam strip and position between sill and bottom of interlock.



- 26 Insert the head T bar into the head with the thin edge sitting flush to the underside, facing inside.



- 27 Pin into position using the brass pins supplied, using the groove in the T bar as a guide.

Fitting and Care Instructions for

JELD-WEN Ledbury Patio Door



28 Insert the lock Jamb T bar into the locking Jamb with the thin edge sitting flush to the inside edge and pin into place using brass pins supplied.



29 Fix sliding door interlock to the inside face of the sliding door flush to the bottom and back edge of the stile. Pre-drill interlock and fix with 6 1" No 6 screws.



30 Fix door into place lifting into head and onto the track.



31 With the sliding door fully opened fit the anti lift centrally into the groove in the top of the door. Fix with 1" No 6 screw, check door slides easily before fixing other screws.



32 Insert key into lock barrel, turn slightly to locate barrel into the lock keep and secure with retaining screw.

Fitting and Care Instructions for

JELD-WEN Ledbury Patio Door

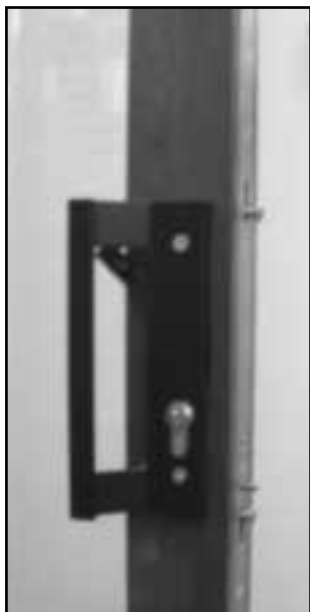

33 Fit the two levers (each side). Handle assembled in Pack as catalogue (RH). Screw into place from the inside.



34 Adjust wheels to max height, then lower by a half turn ensuring lock stile and lock Jamb are parrallel, adjust lock bolts as required.



35 Identify timber threshold and fit pile carrier to groove.

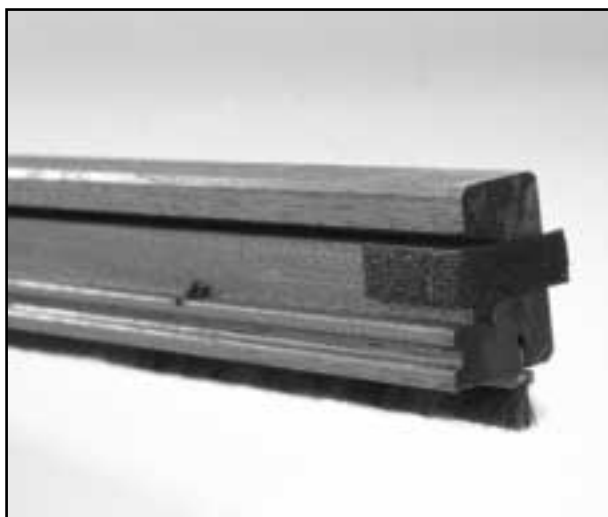

36 Cut a length of the compressed seal end apply to the fixed door end of the threshold.

Fitting and Care Instructions for

JELD-WEN Ledbury Patio Door



37 Fit threshold into place and screw down.



40 Fit keep to interlock sliding door stile centrally.



38 Fit tophead fillet.



41 Fit catch to interlock fixed door stile, to suit keep.



39 Trim the overhanging compressed tape flush to the top of the threshold.



42 Catch correctly fitted.

Fitting and Care Instructions for

JELD-WEN Ledbury Patio Door



- 43 Notch out to fit around pile carrier. Fit rubber stops to timber blocks and fit to the fixed door top and bottom rails, butting up to large pile carriers.



- 44 Recheck adjustment of locking pins and adjust as required.



- 45 Fit mushroom shaped strips into all unused grooves and fit cover caps to open holes.



- 46 Fit flyscreen with screws/pins provided, on outside of fixed doors.



- 47 Fit ventilator with screws provided, on inside of fixed doors.



- 48 Finished patio.

JELD WEN[®]

WINDOWS & DOORS
UNITED KINGDOM

To register under our priority guarantee scheme, please complete and return the form below. Registered installations will be given priority by our customer care team and no call-out charge will be made in the event of service calls. Any manufacturing defects will be repaired free of charge. Installation defects will be charged for parts and labour only.

1. Builder / Installer's name and address (if applicable)

2. Owner / occupier's name

3. Installation address

4. Date of installation _____

5. Did you understand the fitting instructions? Yes / No

6. Was the product decorated before installation / assembly? Yes / No

7. Were parts clearly identifiable and correct? Yes / No

If "no" please give details:

8. Have you any comments to add?

Thank you for your assistance. We trust you are pleased with your Ledbury patio door. This information is required for guarantee registration and product improvement only. It will not be passed to any third party. Your statutory rights are not affected.